

ATS22C11S6U

meki upuštač-ATS22-uprav.110V-snaga208V
(30ks)/230V(40ks)/460V(75ks)/575V(100ks)



Glavno

Range of product	Altistart 22
Product or component type	Soft starter
Product destination	Asynchronous motors
Product specific application	Pumps and fans
Component name	ATS22
Network number of phases	3 phases
[Us] rated supply voltage	208...600 V - 15...10 %
Motor power hp	100 hp 575 V 30 hp 208 V 40 hp 230 V 75 hp 460 V
Factory setting current	96 A
Power dissipation in W	73 W for standard applications
Utilisation category	AC-53A
Type of start	Start with torque control (current limited to 3.5 In)
IcL starter rating	110 A connection in the motor supply line for standard applications
IP degree of protection	IP20

Komplementarno

Assembly style	With heat sink
Function available	Internal bypass
Supply voltage limits	177...660 V
Supply frequency	50...60 Hz - 10...10 %
Network frequency	45...66 Hz
Device connection	In the motor supply line
[Uc] control circuit voltage	110 V - 15...10 % 50/60 Hz
Control circuit consumption	20 W
Discrete output number	2
Discrete output type	Relay outputs R1 230 V running, alarm, trip, stopped, not stopped, starting, ready C/O Relay outputs R2 230 V running, alarm, trip, stopped, not stopped, starting, ready C/O
Minimum switching current	100 mA 12 V DC relay outputs
Maximum switching current	5 A 250 V AC resistive 1 relay outputs 5 A 30 V DC resistive 1 relay outputs 2 A 250 V AC inductive 0.4 20 ms relay outputs 2 A 30 V DC inductive 7 ms relay outputs
Discrete input number	3
Discrete input type	Logic LI1, LI2, LI3 5 mA 20 kOhm
Discrete input voltage	110 V <= 121 V
Discrete input logic	Positive logic LI1, LI2, LI3 < 20 V and <= 15 mA > 79 V <= 2 mA
Output current	0.4...1 Icl adjustable
PTC probe input	750 Ohm
Communication port protocol	Modbus
Connector type	1 RJ45
Communication data link	Serial
Physical interface	RS485 multidrop
Transmission rate	4800, 9600 or 19200 bps

Informacije dane u ovoj dokumentaciji sadrže opće opise i/ili tehničke karakteristike o performansama ovdje sadržanih proizvoda.
Ova dokumentacija nije namijenjena kao zamjena za niti bi se trebala koristiti za određivanje prikladnosti ili pouzdanosti predmetnih proizvoda za konkretne korisničke primjene.
Svaki takav korisnik ili integrator dužan je provesti odgovarajuću i poplunu analizu rizika, procjenu i ispitivanje proizvoda u odnosu na odgovarajuću specifičnu primjenu ili uporabu istog.
Niti društvo Schneider Electric Industries SAS niti bilo koje od njegovih povezanih poduzeća ili podružnica neće preuzeti obvezu ili snositi odgovornost za pogrešnu upotrebu ovdje sadržanih informacija.

Installed device	31
Protection type	Thermal protection motor Phase failure line Thermal protection starter
Marking	CE
Type of cooling	Forced convection
Operating position	Vertical +/- 10 degree
Height	356 mm
Width	150 mm
Depth	229.5 mm
Product weight	18 kg

Okolina

electromagnetic compatibility	Conducted and radiated emissions level A IEC 60947-4-2 Damped oscillating waves level 3 IEC 61000-4-12 Electrostatic discharge level 3 IEC 61000-4-2 Immunity to electrical transients level 4 IEC 61000-4-4 Immunity to radiated radio-electrical interference level 3 IEC 61000-4-3 Voltage/current impulse level 3 IEC 61000-4-5
standards	EN/IEC 60947-4-2
product certifications	CCC CSA C-Tick GOST UL
vibration resistance	1 gn 13...200 Hz EN/IEC 60068-2-6 1.5 mm 2...13 Hz EN/IEC 60068-2-6
shock resistance	15 gn 11 ms EN/IEC 60068-2-27
noise level	56 dB
pollution degree	Level 2 IEC 60664-1
relative humidity	0...95 % without condensation or dripping water EN/IEC 60068-2-3
ambient air temperature for operation	-10...40 °C without derating > 40...< 60 °C with current derating 2.2 % per °C
ambient air temperature for storage	-25...70 °C
operating altitude	<= 1000 m without derating > 1000...< 2000 m with current derating of 2.2 % per additional 100 m

Offer Sustainability

Green Premium product	Green Premium product
Compliant - since 0939 - Schneider Electric declaration of conformity	Compliant - since 0939 - Schneider Electric declaration of conformity
Reference not containing SVHC above the threshold	Reference not containing SVHC above the threshold
Available	Available
Available	Available

Contractual warranty

Warranty period	18 months
-----------------	-----------

Frame Size C

Dimensions

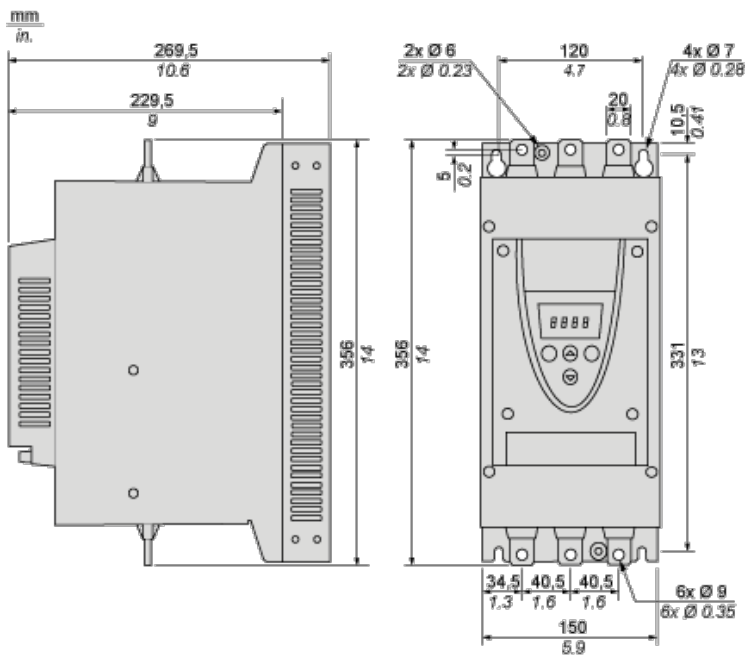

Precautions

Standards

The Altistart 22 soft starter is compliant with pollution Degree 2 as defined in NEMA ICS1-1 or IEC 60664-1.

For environment pollution degree 3, install the Altistart 22 soft starter inside a cabinet type 12 or IP54.

⚠ DANGER

HAZARD OF ELECTRIC SHOCK, EXPLOSION, OR ARC FLASH

ATS22 soft starters are open devices and must be mounted in a suitable enclosure.

Failure to follow these instructions will result in death or serious injury.

Air Circulation

Leave sufficient free space to help the air required for cooling purposes to circulate from the bottom to the top of the unit.

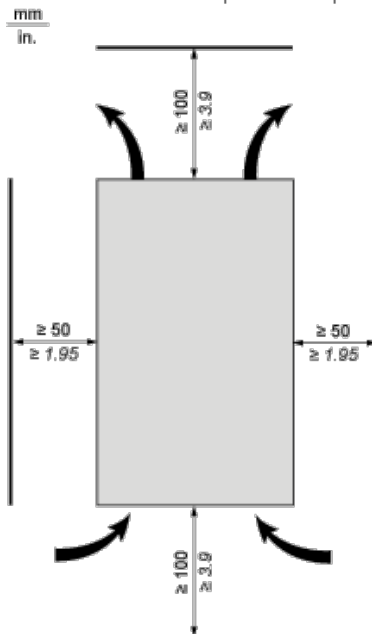

Overheating

To avoid the soft starter to overheat, respect the following recommendations:

- 1 Mount the Altistart 22 Soft Starter within $\pm 10^\circ$ of vertical.
- 1 Do not locate the Altistart 22 Soft Starter near heat radiating elements.
- 1 Electrical current through the Altistart 22 Soft Starter will result in heat losses that must be dissipated into the ambient air immediately surrounding the soft starter. To help prevent a thermal fault, provide sufficient enclosure cooling and/or ventilation to limit the ambient temperature around the soft starter.

- If several soft starters are installed in a control panel, arrange them in a row. Do not stack soft starters. Heat generated from the bottom soft starter can adversely affect the ambient temperature around the top soft starter.

Mounting

Connection Between the Fan and the Altistart 22 Soft Starter

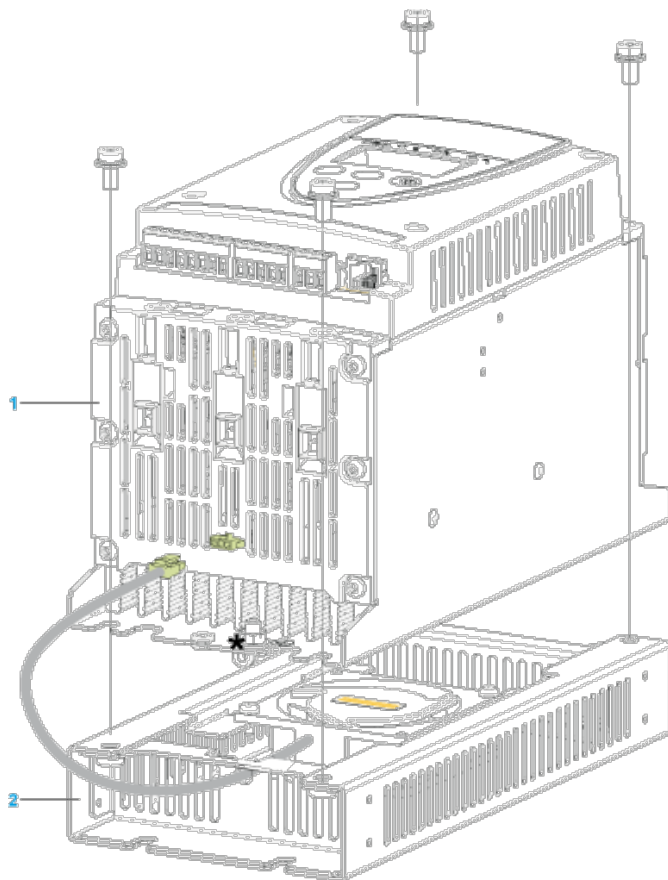

- 1 Altistart 22 Soft Starter
- 2 Fan

Wall mounted or Floor-standing Enclosure with IP 23 Degree of protection

Introduction

To help proper air circulation in the soft starter, grilles and forced ventilation can be installed.

Ventilation Grilles

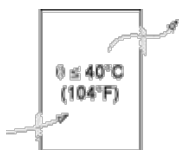

Forced Ventilation Unit

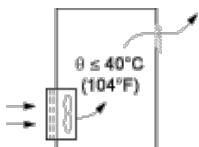

Power Terminal

Bar Style

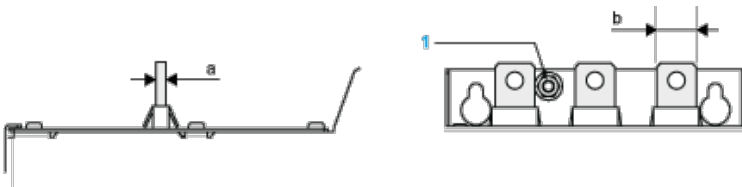

Power supply and output to motor	Bar	b	20 mm (0.79 in)
		a	5 mm (0.2 in)
		Bolt	M8 (0.31 in)
	Cable and protective cover	Size	95 mm ²
		Gauge	250 MCM
		Protective cover	LA9F702
		Tightening torque	18 N.m 157.5 lb.in

Power connections, minimum required wiring section

IEC cable mm ² (Cu 70°C/158°F) (1)	UL cable AWG (Cu 75°C/167°F) (1)
35	1/0

110 Vac control, Logic Inputs (LI) 110 Vac, 3-wire control

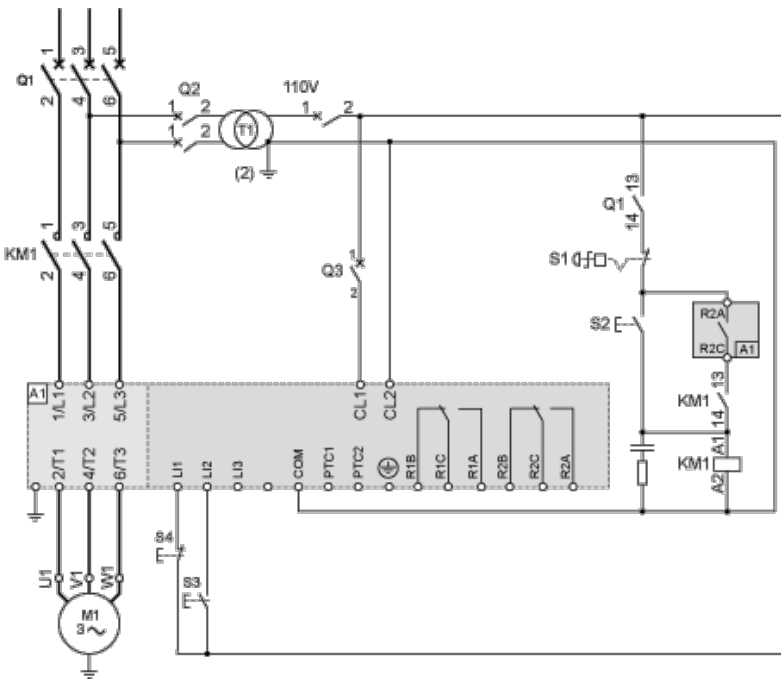

110 Vac control, Logic Inputs (LI) 110 Vac, 2-wire control, freewheelstop

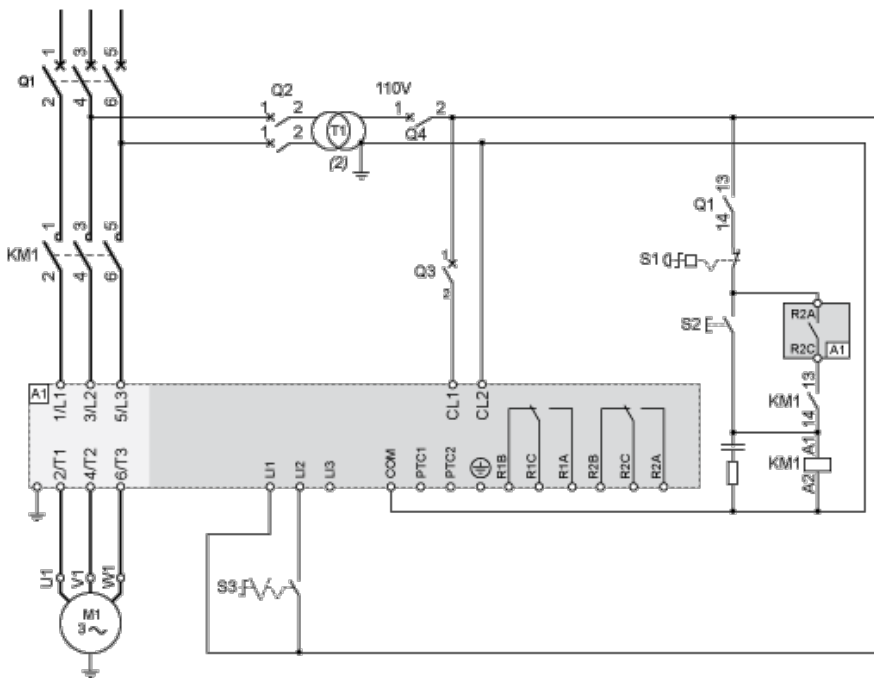

Motor Thermal Protection - Cold Curves

Curves

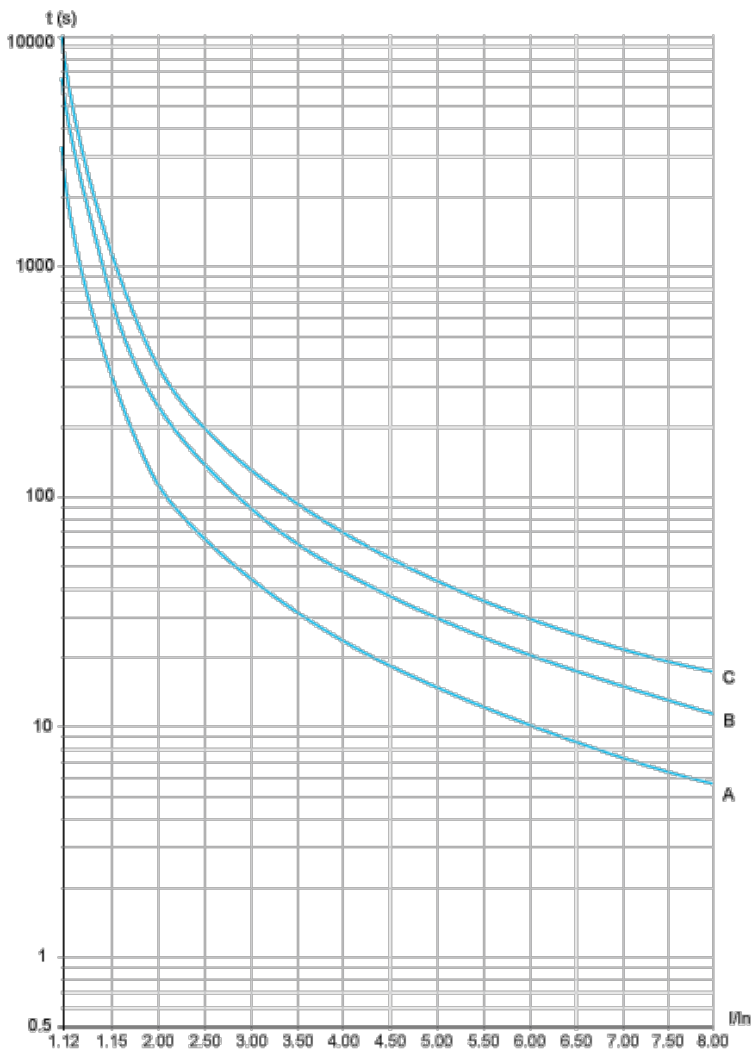

- A Class 10
- B Class 20
- C Class 30

Trip time for a Standard Application (Class 10)

3.5 In

32 s

Trip time for a Severe Application (Class 20)

3.5 In

63 s

Trip time for a Severe Application (Class 30)

3.5 In

95 s

Motor Thermal Protection - Warm Curves

Curves

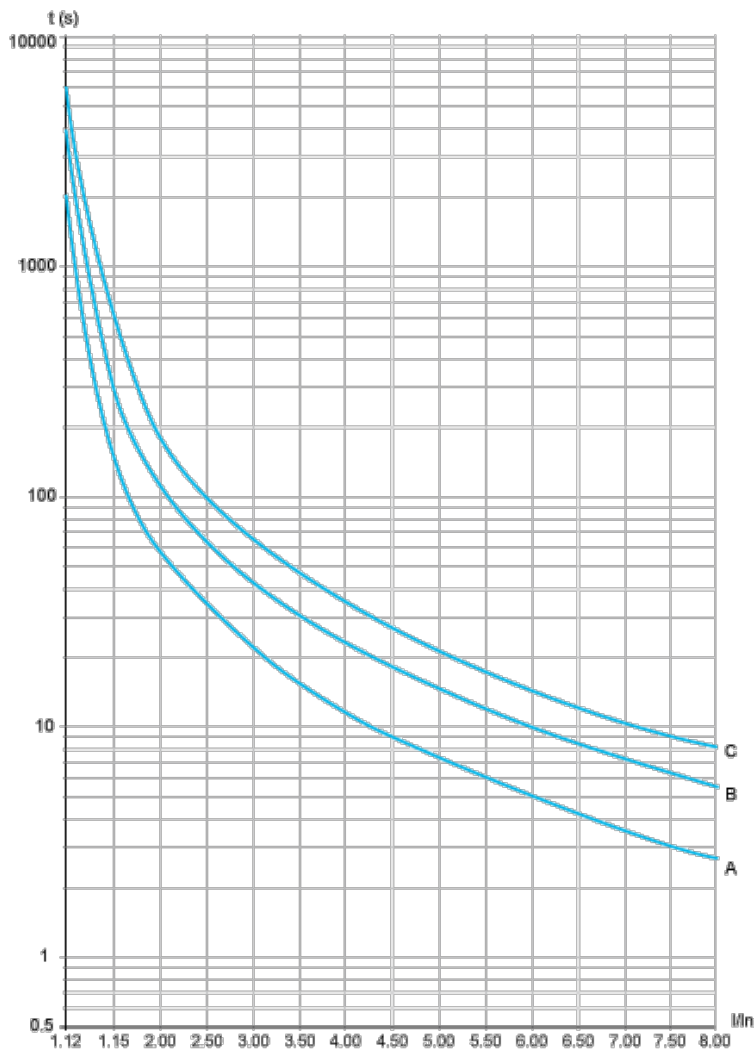

A Class 10

B Class 20

C Class 30

Trip time for a Standard Application (Class 10)

3.5 In

16 s

Trip time for a Severe Application (Class 20)

3.5 In

32 s

Trip time for a Severe Application (Class 30)

3.5 In

48 s