

## K63F003UP

grebenasta preklopka – 3-polni – 60° – 63 A –  
montiranje pomoću vijaka



### Glavno

Range of product	Harmony K
Product or component type	Complete cam switch
Component name	K63
[Ith] conventional free air thermal current	63 A
Mounting location	Front
Fixing mode	4 holes
Cam switch head type	With front plate 64 x 64 mm
Type of operator	Black handle
Rotary handle padlocking	Without
Presentation of legend	With metallic legend, 1 - 0 - 2 black marking
Cam switch function	Changeover switch
Return	Without
Off position	With Off position
Poles description	3P
Switching positions	Left: 0° - 300° Right: 0° - 60°
IP degree of protection	IP40 conforming to IEC 529 IP40 conforming to NF C 20-010

### Komplementarno

Switching angle	60 °
[Ui] rated insulation voltage	690 V degree of pollution 3 conforming to EN 60947-1 690 V degree of pollution 3 conforming to IEC 60947-1
Short-circuit current	10000 A
Short-circuit protection	80 A by cartridge fuse, type gG
[Uimp] rated impulse withstand voltage	6 kV conforming to EN 947-1 6 kV conforming to IEC 947-1
Contact operation	Slow-break
Positive opening	With
Electrical connection	Captive screw clamp terminals flexible, 2 x 10 mm <sup>2</sup> Captive screw clamp terminals solid, 2 x 16 mm <sup>2</sup>
Tightening torque	2.5 N.m
Switching capacity in mA	20000 mA DC at 140 V 3 contact(s) for inductive load (T = 50 ms) 20000 mA DC at 48 V 1 contact(s) for inductive load (T = 50 ms) 20000 mA DC at 95 V 2 contact(s) for inductive load (T = 50 ms) 30000 mA DC at 120 V 2 contact(s) for resistive load (T = 1 ms) 30000 mA DC at 180 V 3 contact(s) for resistive load (T = 1 ms) 30000 mA DC at 60 V 1 contact(s) for resistive load (T = 1 ms) 55000 mA DC at 30 V 1 contact(s) for inductive load (T = 50 ms) 55000 mA DC at 60 V 2 contact(s) for inductive load (T = 50 ms) 55000 mA DC at 90 V 3 contact(s) for inductive load (T = 50 ms) 63000 mA DC at 140 V 3 contact(s) for resistive load (T = 1 ms) 63000 mA DC at 24 V 1 contact(s) for inductive load (T = 50 ms) 63000 mA DC at 24 V 1 contact(s) for resistive load (T = 1 ms) 63000 mA DC at 48 V 1 contact(s) for resistive load (T = 1 ms) 63000 mA DC at 48 V 2 contact(s) for inductive load (T = 50 ms) 63000 mA DC at 48 V 2 contact(s) for resistive load (T = 1 ms) 63000 mA DC at 70 V 3 contact(s) for inductive load (T = 50 ms) 63000 mA DC at 70 V 3 contact(s) for resistive load (T = 1 ms) 63000 mA DC at 95 V 2 contact(s) for resistive load (T = 1 ms)
Mechanical durability	300000 cycles
CAD overall width	64 mm

Informacije dane u ovoj dokumentaciji sadrže opće opise i/ili tehničke karakteristike o performansama ovdje sadržanih proizvoda. Ova dokumentacija nije namijenjena kao zamjena za niti bi se trebala koristiti za određivanje prikladnosti ili pouzdanosti predmetnih proizvoda za konkretne korisničke primjene. Svaki takav korisnik ili integrator dužan je provesti odgovarajuću i potpunu analizu rizika, procjenu i ispitivanje proizvoda u odnosu na odgovarajuću specifičnu primjenu ili uporabu istog. Niti društvo Schneider Electric Industries SAS niti bilo koje od njegovih povezanih poduzeća ili podružnica neće preuzeti obvezu ili snositi odgovornost za pogrešnu upotrebu ovdje sadržanih informacija.

CAD overall height	64 mm
CAD overall depth	132 mm
Product weight	0.59 kg

## Okolina

standards	EN/IEC 60947-3
product certifications	CULus 120 V 3 hp 1 phase CULus 240 V 10 hp 3 phases CULus 480 V 25 hp 3 phases CULus 240 V 7.5 hp 1 phase
protective treatment	TC
ambient air temperature for operation	-25...55 °C
ambient air temperature for storage	-40...70 °C
overvoltage category	Class II conforming to IEC 60536 Class II conforming to NF C 20-030

## Contractual warranty

Warranty period	18 months
-----------------	-----------

## Dimensions

### Front Mounting

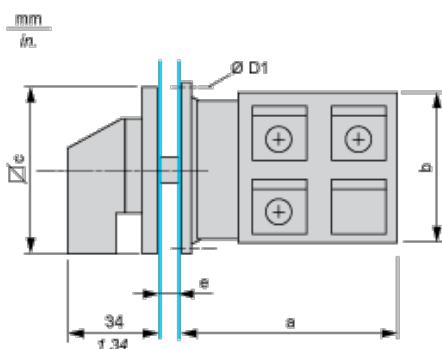

e support panel thickness 0.5 to 5.5 mm / 0.02 to 0.22 in in.

a		b		c		D1	
mm	in.	mm	in.	mm	in.	mm	in.
92.8	3.65	66	2.60	64	2.52	5.4	0.21

## Panel Cut-Out

### Front Mounting

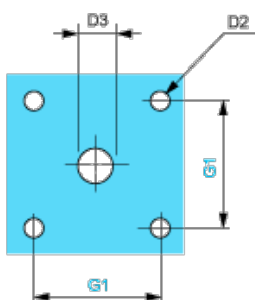

D2		D3		G1	
mm	in.	mm	in.	mm	in.
4.5	0.18	10	0.39	48	1.89

## Link Positions (Factory Mounted)

### Diagram for 1 to 4-pole Switches

Select the number of poles according to the product characteristics

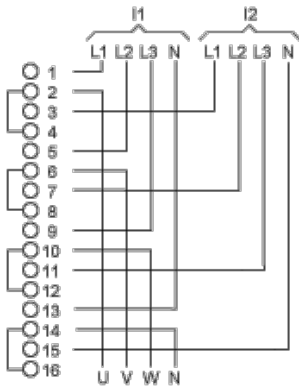

I1 Input 1

I2 Input 2

## Marking

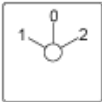

## Angular Position of Switch



## Switching Program

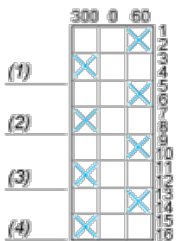

(1) 1-pole

(2) 2-pole

(3) 3-pole

(4) 4-pole

## Convention Used for Switching Program Representation

 Contact closed

 Contact closed in 2 positions and maintained between the 2 positions

 Sealed assembly for auto-maintain control

 Overlapping contacts

 Spring return position: for a switching angle of 90°, spring return is over 30° after the last position (for a maximum of 3

simultaneous contacts).

Example:

