

ZB4BA38

glava zelenog upuštenog svjetlećeg tipkala Ø 22
opružni povrat za integralni LED



Glavno

| | |
|---------------------------------|----------------------------------|
| Range of product | Harmony XB4 |
| Product or component type | Head for illuminated push-button |
| Device short name | ZB4 |
| Product compatibility | Integral LED |
| Bezel material | Chromium plated metal |
| Head type | Standard |
| Mounting diameter | 22 mm |
| Sale per indivisible quantity | 1 |
| Shape of signaling unit head | Round |
| Type of operator | Spring return |
| Operator profile | Green flush unmarked |
| Operator additional information | For insertion of legend |

Komplementarno

| | |
|------------------------------------|---|
| CAD overall width | 29 mm |
| CAD overall height | 29 mm |
| CAD overall depth | 30 mm |
| Product weight | 0.028 kg |
| Resistance to high pressure washer | 7000000 Pa at 55 °C, distance: 0.1 m |
| Mechanical durability | 10000000 cycles |
| Electrical composition code | C4for 6 contacts using single and double blocks in front mounting C3for 6 contacts using single blocks in front mounting M1 for 6 contacts using single blocks in front mounting with integral LED M2 for 6 contacts using single and double blocks in front mounting with integral LED M6 for 2 contacts using single blocks in front mounting with integral LED and transformer M10 for 2 contacts using single blocks in front mounting with integral LED C14 for 2 contacts using single blocks in front mounting |

Okolina

| | |
|---------------------------------------|---|
| protective treatment | TH |
| ambient air temperature for storage | -40...70 °C |
| ambient air temperature for operation | -40...70 °C |
| overvoltage category | Class I conforming to IEC 60536 |
| IP degree of protection | IP67 IP66 conforming to IEC 60529 IP69K IP69 |
| NEMA degree of protection | NEMA 13 NEMA 4X |
| IK degree of protection | IK06 conforming to EN 50102 |
| standards | EN/IEC 60947-1 EN/IEC 60947-5-1 EN/IEC 60947-5-4 EN/IEC 60947-5-5 JIS C 4520 UL 508 CSA C22.2 No 14 |
| product certifications | BV CSA DNV GL |

Informacije dane u ovoj dokumentaciji sadrže opće opise i/ili tehničke karakteristike o performansama ovdje sadržanih proizvoda. Ova dokumentacija nije namijenjena kao zamjena za niti bi se trebala koristiti za određivanje prikladnosti ili pouzdanosti predmetnih proizvoda za konkretne korisničke primjene. Svaki takav korisnik ili integrator dužan je provesti odgovarajuću i poplunu analizu rizika, procjenu i ispitivanje proizvoda u odnosu na odgovarajuću specifičnu primjenu ili uporabu istog. Niti društvo Schneider Electric Industries SAS niti bilo koje od njegovih povezanih poduzeća ili podružnica neće preuzeti obvezu ili snositi odgovornost za pogrešnu upotrebu ovdje sadržanih informacija.

LROS (Lloyds register of shipping)
 RINA
 UL listed

| | |
|----------------------|--|
| vibration resistance | 5 gn (f = 2...500 Hz) conforming to IEC 60068-2-6 |
| shock resistance | 30 gn (duration = 18 ms) for half sine wave acceleration conforming to IEC 60068-2-27 50 gn (duration = 11 ms) for half sine wave acceleration conforming to IEC 60068-2-27 |

Contractual warranty

| | |
|-----------------|-----------|
| Warranty period | 18 months |
|-----------------|-----------|

Dimensions

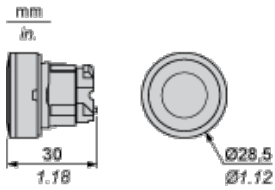

Panel Cut-out for Pushbuttons, Switches and Pilot Lights (Finished Holes, Ready for Installation)

| Connection by Screw Clamp Terminals or Plug-in Connectors or on Printed Circuit Board | Connection by Faston Connectors |
|---|---------------------------------|
| | |
| <p>(1) Diameter on finished panel or support (2) 40 mm min. / 1.57 in. min. (3) 30 mm min. / 1.18 in. min. (4) Ø 22.5 mm / 0.89 in. recommended (Ø 22.3 mm₀^{+0.4} / 0.88 in.₀^{+0.016}) (5) 45 mm min. / 1.78 in. min. (6) 32 mm min. / 1.26 in. min.</p> | |

Pushbuttons, Switches and Pilot Lights for Printed Circuit Board Connection

Panel Cut-outs (Viewed from Installer's Side)



A: 30 mm min. / 1.18 in. min.

B: 40 mm min. / 1.57 in. min.

Printed Circuit Board Cut-outs (Viewed from Electrical Block Side)

Dimensions in mm



A: 30 mm min.

B: 40 mm min.

Dimensions in in.

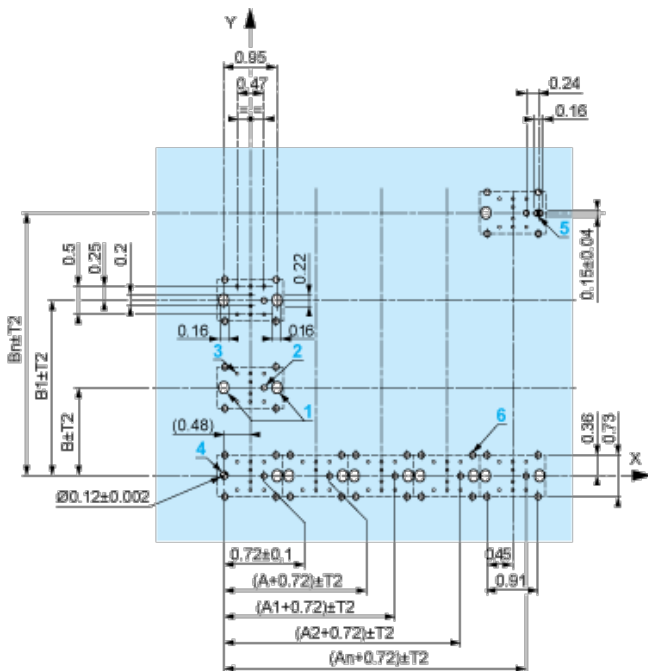

A: 1.18 in. min.

B: 1.57 in. min.

General Tolerances of the Panel and Printed Circuit Board

The cumulative tolerance must not exceed 0.3 mm / 0.012 in: $T1 + T2 = 0.3 \text{ mm max.}$

Installation Precautions

- | Minimum thickness of circuit board: 1.6 mm / 0.06 in.
- | Cut-out diameter: 22.4 mm \pm 0.1 / 0.88 in. \pm 0.004
- | Orientation of body/fixing collar ZB4 BZ009: $\pm 2^\circ 30'$ (excluding cut-outs marked **a** and **b**).
- | Tightening torque of screws ZBZ 006: 0.6 N.m (5.3 lbf.in) max.
- | Allow for one ZB4 BZ079 fixing collar/pillar and its fixing screws:
 - | every 90 mm / 3.54 in. horizontally (X), and 120 mm / 4.72 in. vertically (Y).
 - | with each selector switch head (ZB4 BD*, ZB4 BJ*, ZB4 BG*).

The fixing centers marked **a** and **b** are diagonally opposed and must align with those marked 4 and 5.

$\frac{\text{mm}}{\text{in.}}$

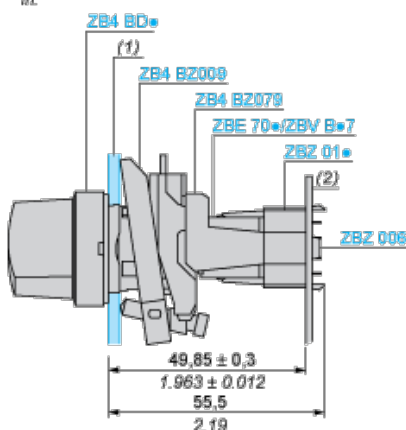

(1) Panel

(2) Printed circuit board

Mounting of Adapter (Socket) ZBZ 01*

- | 1 2 elongated holes for ZBZ 006 screw access
- | 2 1 hole $\varnothing 2.4 \text{ mm} \pm 0.05 / 0.09 \text{ in.} \pm 0.002$ for centring adapter ZBZ 01*
- | 3 8 $\times \varnothing 1.2 \text{ mm} / 0.05 \text{ in.}$ holes
- | 4 1 hole $\varnothing 2.9 \text{ mm} \pm 0.05 / 0.11 \text{ in.} \pm 0.002$, for aligning the printed circuit board (with cut-out marked **a**)
- | 5 1 elongated hole for aligning the printed circuit board (with cut-out marked **b**)
- | 6 4 holes $\varnothing 2.4 \text{ mm} / 0.09 \text{ in.}$ for clipping in adapter ZBZ 01*

Electrical Composition Corresponding to Code C3



Electrical Composition Corresponding to Code C4



Electrical Composition Corresponding to Codes C14, SF2 and SR2

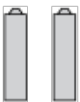

Electrical Composition Corresponding to Codes M1 and M7

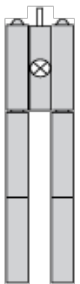

Electrical Composition Corresponding to Codes M2 and M8

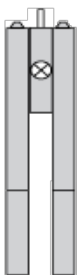

Electrical Composition Corresponding to Codes M6 and P2



Electrical Composition Corresponding to Codes M5, M10, MF1, MR1 and MF2

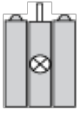

Legend

Single contact



Double contact



Light block



Possible location

