

## ZB5AW35

glava narančastog upu.g svjetleć.tipkala Ø22 opružni povrat za žaruljicu BA9s



### Glavno

Range of product	Harmony XB5
Product or component type	Head for illuminated push-button
Device short name	ZB5
Product compatibility	BA 9s
Bezel material	Plastic
Mounting diameter	22 mm
Sale per indivisible quantity	1
Head type	Standard
Shape of signaling unit head	Round
Type of operator	Spring return
Operator profile	Orange flush unmarked
Operator additional information	With plain lens

### Komplementarno

CAD overall width	29 mm
CAD overall height	29 mm
CAD overall depth	32 mm
Product weight	0.018 kg
Resistance to high pressure washer	7000000 Pa at 55 °C, distance: 0.1 m
Mechanical durability	10000000 cycles
Station name	XALD 1...5 cut-outs XALK 2...5 cut-outs
Electrical composition code	M7 for 6 contacts using single blocks in front mounting with BA 9s M8 for 6 contacts using single and double blocks in front mounting with BA 9s M9 for 2 contacts using single blocks in front mounting with BA 9s and transformer MF2 for 2 contacts using single blocks in front mounting with BA 9s

### Okolina

protective treatment	TC
ambient air temperature for storage	-40...70 °C
ambient air temperature for operation	-40...55 °C
overvoltage category	Class II conforming to IEC 60536
IP degree of protection	IP67 IP66 conforming to IEC 60529 IP69K IP69
NEMA degree of protection	NEMA 13 NEMA 4X
IK degree of protection	IK05 conforming to EN 50102
standards	EN/IEC 60947-1 EN/IEC 60947-5-1 EN/IEC 60947-5-4 JIS C 4520 UL 508 GB 14048.5 CSA C22.2 No 14
product certifications	BV CSA DNV GL LROS (Lloyds register of shipping)

Informacije dane u ovoj dokumentaciji sadrže opće opise i/ili tehničke karakteristike o performansama ovdje sadržanih proizvoda. Ova dokumentacija nije namijenjena kao zamjena za niti bi se trebala koristiti za određivanje prikladnosti ili pouzdanosti predmetnih proizvoda za konkretne korisničke primjene. Svaki takav korisnik ili integrator dužan je provesti odgovarajuću i potpunu analizu rizika, procjenu i ispitivanje proizvoda u odnosu na odgovarajuću specifičnu primjenu ili uporabu istog. Niti društvo Schneider Electric Industries SAS niti bilo koje od njegovih povezanih poduzeća ili podružnica neće preuzeti obvezu ili snositi odgovornost za pogrešnu upotrebu sadržanih informacija.

RINA  
UL listed

vibration resistance	5 gn (f = 2...500 Hz) conforming to IEC 60068-2-6
shock resistance	30 gn (duration = 18 ms) for half sine wave acceleration conforming to IEC 60068-2-27 50 gn (duration = 11 ms) for half sine wave acceleration conforming to IEC 60068-2-27

### Contractual warranty

Warranty period	18 months
-----------------	-----------

### Dimensions

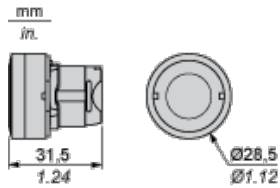

### Panel Cut-out for Pushbuttons, Switches and Pilot Lights (Finished Holes, Ready for Installation)

Connection by Screw Clamp Terminals or Plug-in Connectors or on Printed Circuit Board

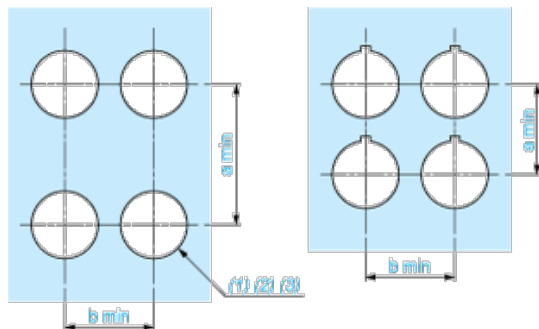

- (1) Diameter on finished panel or support
- (2) For selector switches and Emergency stop buttons, use of an anti-rotation plate type ZB5AZ902 is recommended.
- (3)  $\varnothing 22.5$  mm recommended ( $\varnothing 22.3 \text{ }_0^{+0.4}$ ) /  $\varnothing 0.89$  in. recommended ( $\varnothing 0.88 \text{ in. }_0^{+0.016}$ )

Connections	a in mm	a in in.	b in mm	b in in.
By screw clamp terminals or plug-in connector	40	1.57	30	1.18
By Faston connectors	45	1.77	32	1.26
On printed circuit board	30	1.18	30	1.18

### Detail of Lug Recess

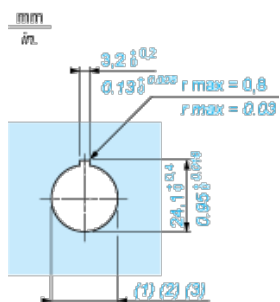

- (1) Diameter on finished panel or support
- (2) For selector switches and Emergency stop buttons, use of an anti-rotation plate type ZB5AZ902 is recommended.
- (3)  $\varnothing 22.5$  mm recommended ( $\varnothing 22.3 \text{ }_0^{+0.4}$ ) /  $\varnothing 0.89$  in. recommended ( $\varnothing 0.88 \text{ in. }_0^{+0.016}$ )

## Pushbuttons, Switches and Pilot Lights for Printed Circuit Board Connection

### Panel Cut-outs (Viewed from Installer's Side)

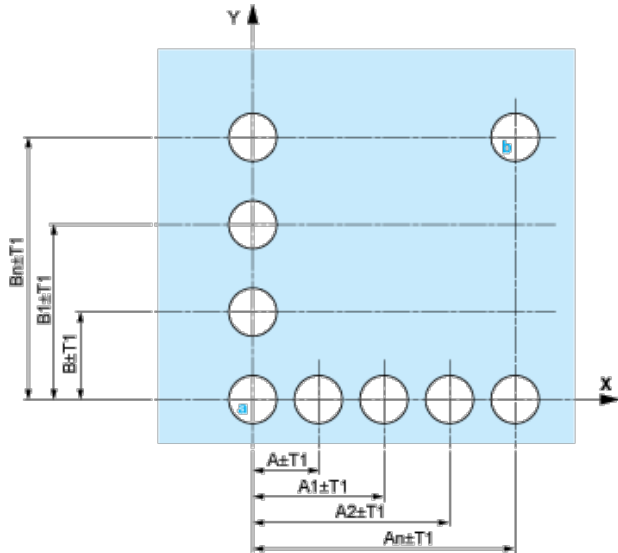

A: 30 mm min. / 1.18 in. min.

B: 40 mm min. / 1.57 in. min.

### Printed Circuit Board Cut-outs (Viewed from Electrical Block Side)

Dimensions in mm

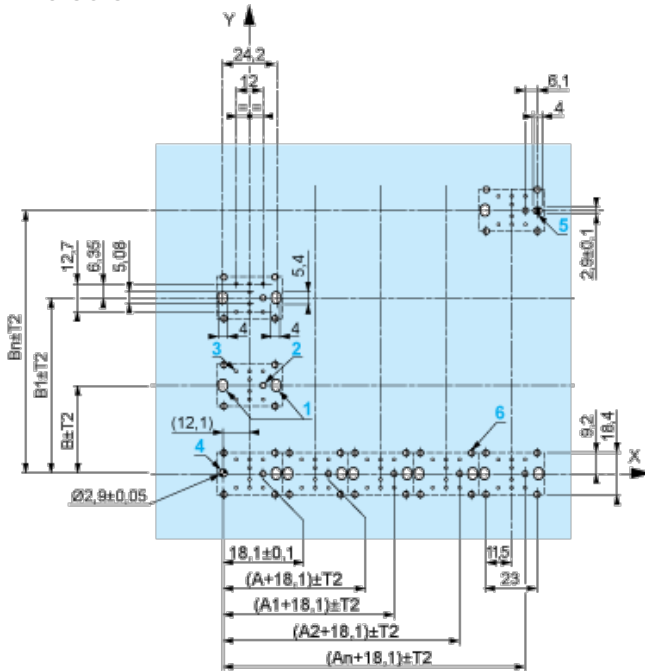

A: 30 mm min.

B: 40 mm min.

Dimensions in in.



A: 1.18 in. min.

B: 1.57 in. min.

### General Tolerances of the Panel and Printed Circuit Board

The cumulative tolerance must not exceed 0.3 mm / 0.012 in.:  $T_1 + T_2 = 0.3 \text{ mm max.}$

### Installation Precautions

- | Minimum thickness of circuit board: 1.6 mm / 0.06 in.
- | Cut-out diameter: 22.4 mm  $\pm$  0.1 / 0.88 in.  $\pm$  0.004
- | Orientation of body/fixing collar ZB5AZ009:  $\pm$  2°30' (excluding cut-outs marked **a** and **b**).
- | Tightening torque of screws ZBZ006: 0.6 N.m (5.3 lbf.in) max.
- | Allow for one ZB5AZ079 fixing collar/pillar and its fixing screws:
  - | every 90 mm / 3.54 in. horizontally (X), and 120 mm / 4.72 in. vertically (Y).
  - | with each selector switch head (ZB5AD•, ZB5AJ•, ZB5AG•).

The fixing centers marked **a** and **b** are diagonally opposed and must align with those marked 4 and 5.



- (1) Head ZB5AD•
- (2) Panel
- (3) Nut
- (4) Printed circuit board

### Mounting of Adapter (Socket) ZBZ01•

- | 1 2 elongated holes for ZBZ006 screw access
- | 2 1 hole  $\varnothing$  2.4 mm  $\pm$  0.05 / 0.09 in.  $\pm$  0.002 for centring adapter ZBZ01•
- | 3 8  $\times$   $\varnothing$  1.2 mm / 0.05 in. holes
- | 4 1 hole  $\varnothing$  2.9 mm  $\pm$  0.05 / 0.11 in.  $\pm$  0.002, for aligning the printed circuit board (with cut-out marked **a**)

- | 5 1 elongated hole for aligning the printed circuit board (with cut-out marked **b**)
- | 6 4 holes  $\varnothing$  2.4 mm / 0.09 in. for clipping in adapter ZBZ01•

Dimensions An + 18.1 relate to the  $\varnothing$  2.4 mm  $\pm$  0.05 / 0.09 in.  $\pm$  0.002 holes for centring adapter ZBZ01•.

### Electrical Composition Corresponding to Codes M1 and M7

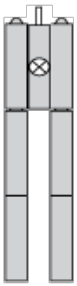

### Electrical Composition Corresponding to Codes M2 and M8

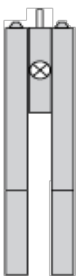

### Electrical Composition Corresponding to Code M9

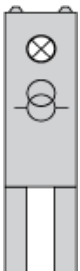

### Electrical Composition Corresponding to Codes M5, M10, MF1, MR1 and MF2

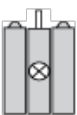

### Legend

Single contact



Double contact



Light block



Possible location

