

## ZB6CD42

glava crvene pravokutne preklopke Ø 16 2 položaja  
nepomična



### Glavno

Range of product	Harmony XB6
Product or component type	Head for selector switch
Device short name	ZB6
Bezel material	Plastic
Mounting diameter	16 mm
Sale per indivisible quantity	1
Shape of signaling unit head	Square
Type of operator	Stay put
Operator profile	Red standard handle
Operator position information	2 positions 60°

### Komplementarno

CAD overall width	18 mm
CAD overall height	18 mm
CAD overall depth	43 mm
Product weight	0.018 kg

### Okolina

protective treatment	TC
ambient air temperature for storage	-40...70 °C
ambient air temperature for operation	-25...70 °C
electrical shock protection class	Class II conforming to IEC 61140
IP degree of protection	IP65 conforming to IEC 60529
NEMA degree of protection	NEMA 4 UL 50 NEMA 13 UL 50 NEMA 4X UL 50 NEMA 13 CSA C22.2 No 94 NEMA 4 CSA C22.2 No 94 NEMA 4X CSA C22.2 No 94
standards	EN/IEC 60947-1 EN/IEC 60947-5-1 EN/IEC 60947-5-5 JIS C 4520 JIS C 852 UL 508 CSA C22.2 No 14
product certifications	CCC CSA GOST UL
vibration resistance	+/- 3 mm (f = 2...500 Hz) conforming to IEC 60068-2-6 5 gn (f = 2...500 Hz) conforming to IEC 60068-2-6
shock resistance	30 gn (duration = 18 ms) for half sine wave acceleration conforming to IEC 60068-2-27 50 gn (duration = 11 ms) for half sine wave acceleration conforming to IEC 60068-2-27

### Contractual warranty

Warranty period	18 months
-----------------	-----------

## Square Head for Selector Switch, Standard Handle

### Dimensions

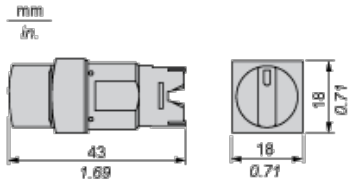

### Panel Cut-out

#### For Square or Circular Head

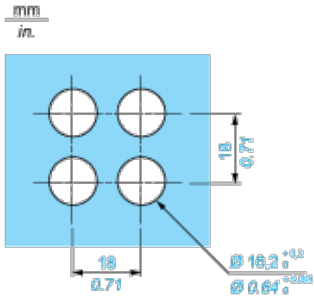

## Pushbuttons, Switches and Pilot Lights for Printed Circuit Board Connection

### Front Panel Cut-out (Viewed from Installer's Side)

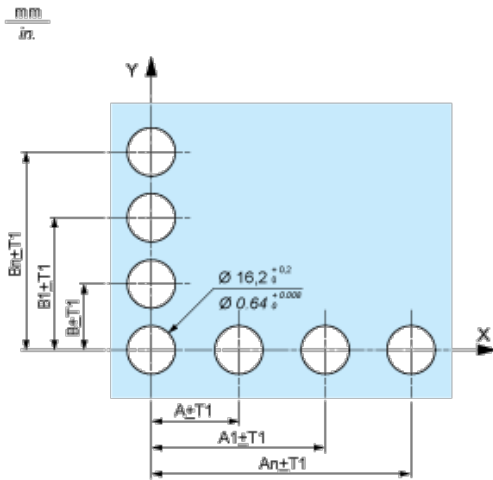

### Printed Circuit Board Drillings (Viewed from Electrical Block Side)

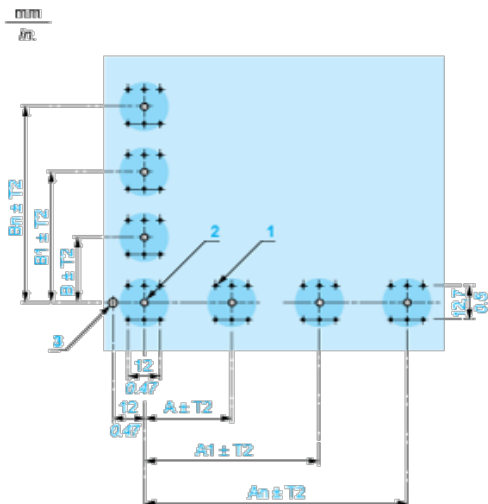

- A 24 mm/0.94 in. minimum for rectangular heads, 18 mm/0.71 in. minimum for square or circular heads
- B 18 mm/0.71 in. minimum
- (1) 6 x Ø 1.1 mm / 6 x Ø 0.04 in. holes.
- (2) 1 x Ø 2.6<sup>0</sup><sub>-0.2</sub> mm / 1 x Ø 0.10<sup>0</sup><sub>-0.008</sub> in. hole for locating pin, only when using socket adaptor ZB6Y010.
- (3) 1 x Ø 3.2<sup>0</sup><sub>-0.2</sub> mm / 1 x Ø 0.13<sup>0</sup><sub>-0.008</sub> in. hole for fixing of printed circuit board onto the front panel using body bracket ZB6Y011. This hole must be drilled on the left-hand side, when heads are positioned at the normal angle. Fit a body bracket ZB6Y011 every 72 mm/2.83 in. maximum for cut-outs on 24 mm/0.94 in. centres (rectangular heads) and 54 mm/2.13 in. maximum for cut-outs on 18 mm/0.71 in. centres (square or circular heads).

**General tolerances of the panel and printed circuit board: T1, T2: T1 + T2 = 0.3 mm/0.01 in. maximum.**

**Installation precautions:**

Thickness of printed circuit board: 1.6 mm/0.06 in. minimum.

**Mounting with Body Bracket**

**With socket adaptor ZB6Y010**

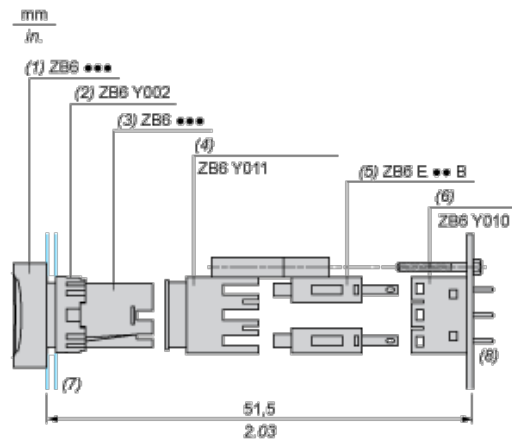

- (1) Head
- (2) Nut
- (3) Body
- (4) Body bracket
- (5) Contact block
- (6) Socket adaptor
- (7) Panel
- (8) Printed circuit

**Direct mounting without socket adaptor ZB6Y010**



- (1) Head
- (2) Nut
- (3) Body
- (4) Body bracket
- (5) Contact block
- (6) Panel
- (7) Printed circuit